

SMART Board 540

WI.231c, Interactive Whiteboard

These drawings are for outline and installation purposes only.

All dimensions given in inches [millimeters].

Dimensions are subject to change without notice.

All dimensions +/- 1/8" (3 mm).

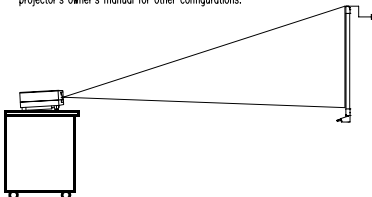

This figure represents a floor-configured projector and is for illustrative purposes only. Consult your projector's owner's manual for other configurations.

SETTING UP THE PROJECTOR
After you set up your projector, turn it on and mark the top edge of the image on the wall. The mounting holes for the interactive whiteboard will be approximately 5" (127 mm) below this line. Consult your projector's owner's manual for the throw-distance calculation.

FASTENING THE WALL-MOUNT BRACKET
When you mount the interactive whiteboard on drywall, use the supplied wall-mount anchors and # 8 x 1-1/4" screws. These are labelled SBS-MWKIT and are located in the accessory box.

HANGING THE SMART BOARD INTERACTIVE WHITEBOARD
When you hang or install the interactive whiteboard, consider the following:

1. Ensure there's at least 1.25" (31.8 mm) clearance above the interactive whiteboard for installation and ease of removal.
2. Test if the interactive whiteboard is secure by sliding it slightly sideways.
3. If the interactive whiteboard is to be enclosed, make sure you can remove it for service.

CONNECTION INFORMATION
The interactive whiteboard connects to a computer via a proprietary 20' (6.1 m) serial/power cable or 21.5' (6.6 m) USB cable (no external power supply is required unless you extend the cable). You can also use a proprietary wireless alternative (a power outlet is required near the interactive whiteboard).

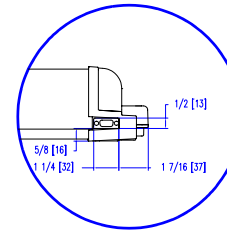
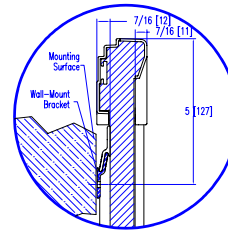
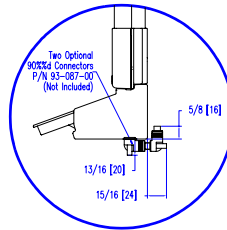
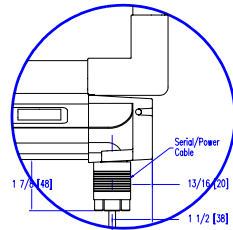
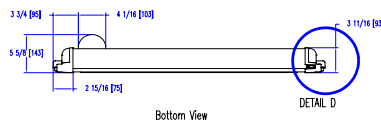
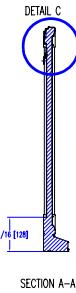
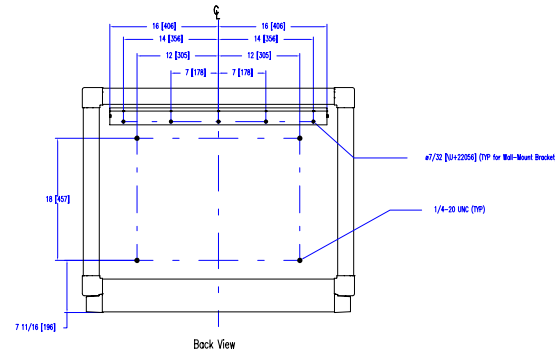
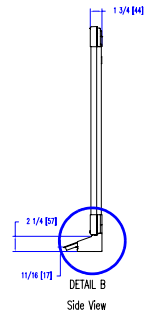
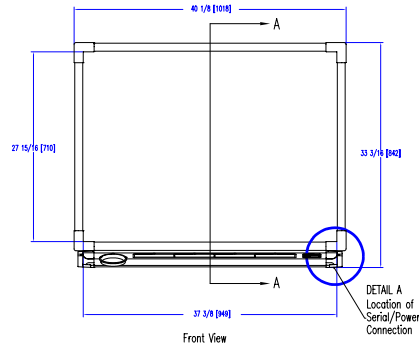
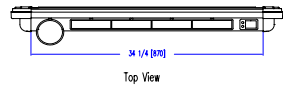

Suite 600, 1177 - 11th Avenue SW
Calgary, AB CANADA T2R 1K9

Support:
1.888.518.6791 (Canada/U.S.) or
+1.403.228.5940 (all other countries)

Main Switchboard:
1.888.42.SMART (Canada/U.S.) or
+1.403.245.0333 (all other countries)

Fax:
+1.403.228.2500
info@smarttech.com
www.smarttech.com

© SMART Technologies Inc. All rights reserved. SMART Board and the SMART logo are trademarks of SMART Technologies Inc. 09/2003.