

SMART Board

1/2 Fatigue Resistant 231c 560 Interactive Whiteboard

These drawings are for outline and installation purposes only.

All dimensions given in inches [millimeters].

Dimensions are subject to change without notice.

All dimensions +/- 1/8" (3 mm).

NOTE: DO NOT SCALE.

This figure represents a floor-configured projector and is for illustrative purposes only. Consult your projector's owner's manual for other configurations.

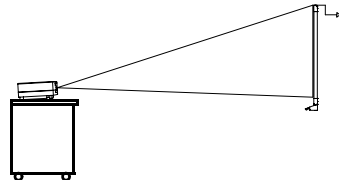

SETTING UP THE PROJECTOR

After you set up your projector, turn it on and mark the top edge of the image on the wall. The mounting holes for the interactive whiteboard will be approximately 5" (127 mm) below this line. Consult your projector's owner's manual for the throw-distance calculation.

FASTENING THE WALL-MOUNT BRACKET

When you mount the interactive whiteboard on drywall, use the supplied wall-mount anchors and # 8 x 1-1/4" screws. These are labelled SB5-WMKIT and are located in the accessory box.

HANGING THE SMART BOARD INTERACTIVE WHITEBOARD

When you hang or install the interactive whiteboard, consider the following:

1. Ensure there's at least 1.25" (31.8 mm) clearance above the interactive whiteboard for installation and ease of removal.
2. Test if the interactive whiteboard is secure by sliding it slightly sideways.
3. If the interactive whiteboard is to be enclosed, make sure you can remove it for service.

CONNECTION INFORMATION

The interactive whiteboard connects to a computer via a proprietary 20' (6.1 m) serial/power cable or 21.5' (6.6 m) USB cable (no external power supply is required unless you extend the cable). You can also use a proprietary wireless alternative (a power outlet is required near the interactive whiteboard).

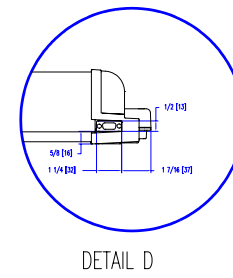
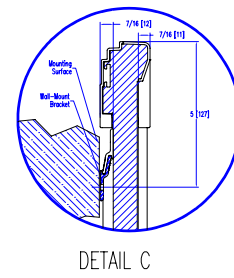
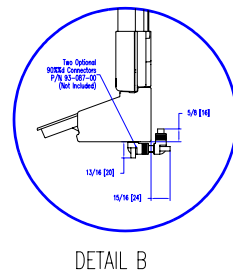
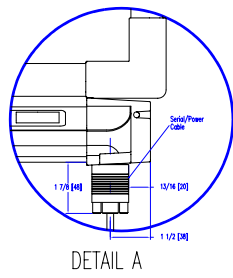
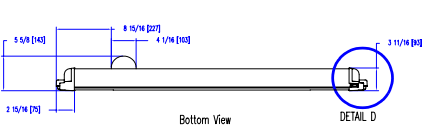
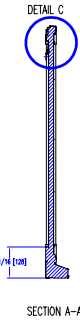
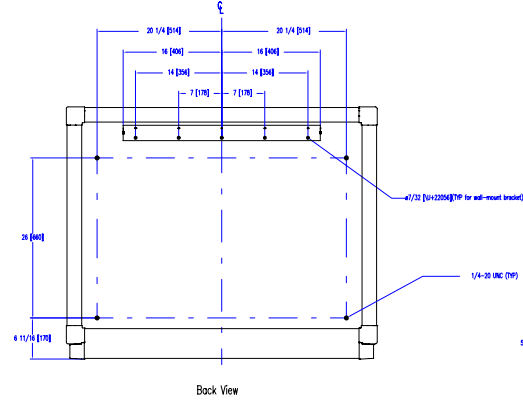
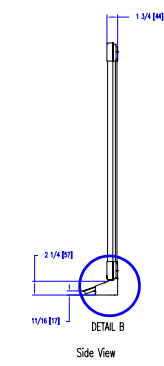
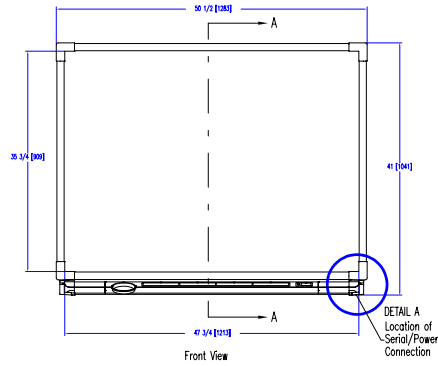
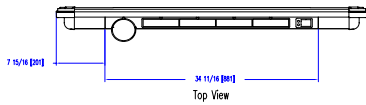

A B C D E F G H I



Suite 600, 1177 - 11th Avenue SW
Calgary, AB CANADA T2R 1K9

Main Switchboard:
1.888.42.SMART (Canada/U.S.) or
+1.403.245.0333 (all other countries)

Support Tel:
1.888.518.6791 (Canada/U.S.) or
+1.403.228.5940 (all other countries)

Support Fax:
+1.403.806.1256

info@smarttech.com www.smarttech.com

© SMART Technologies Inc. All rights reserved.
SMART Board and the SMART logo are
trademarks of SMART Technologies Inc.
11/2003.